

dance

Sculptural separee

Design:
Pongratz Perbellini Architects
Christian R. Pongratz and Maria R. Perbellini
www.pongratz-perbellini.com

pongratzperbellini
© 2005
Floorstudio

Specifications:
Materials: **Corian sheets, colour Glacier White**
Size: **single sheet 930x2000 mm., thickness 12,3 mm.**
Technical characteristics: **CNC milled and thermoformed**

Prices: **upon request**

Dance is a sculptural room divider, which allows a flexible arrangement and division of spaces but permits visual interaction.

The separee is composed out of seven sheets of Corian surfaces, suspended from the ceiling on steel cables and secured with floor clips. Cuts & bends in the Corian “*skin*”, give partial views across small openings. These little “*peel-offs*” work also as small shelves. For a client consultation zone, several fluorescent lamps were integrated into the Corian sheets.



dance

a fluid Corian wall

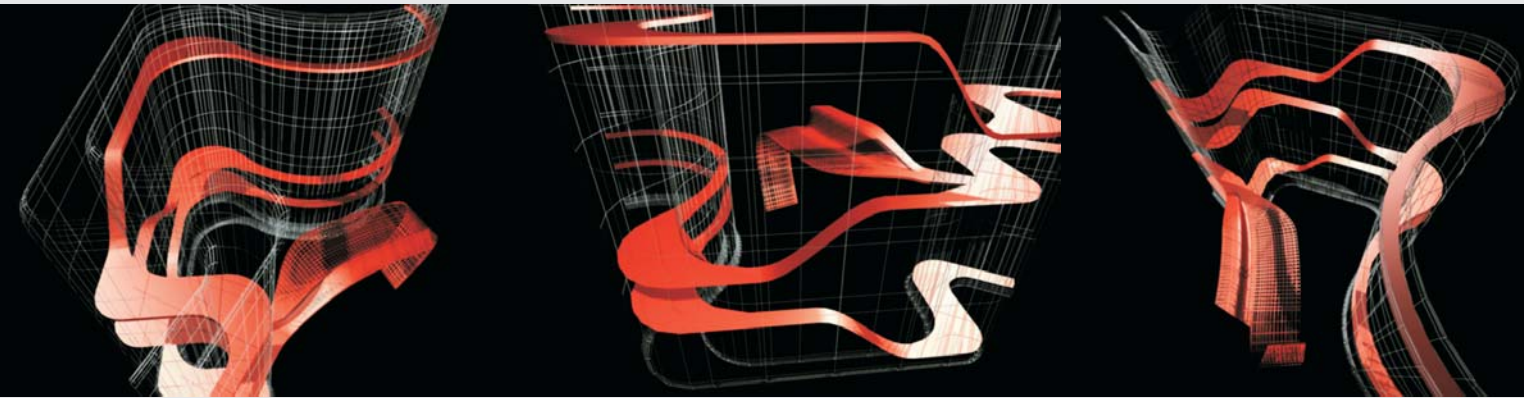

dance concept

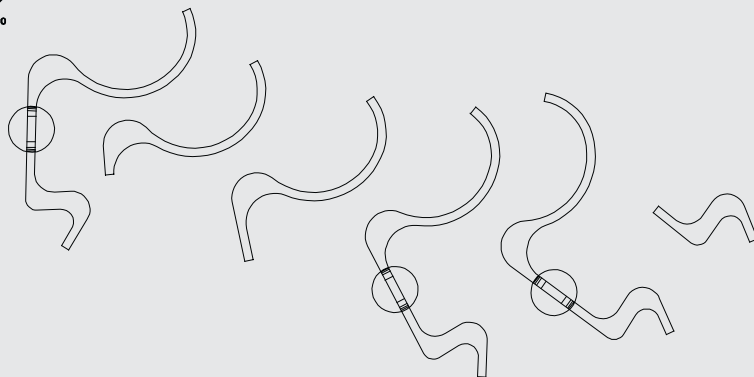
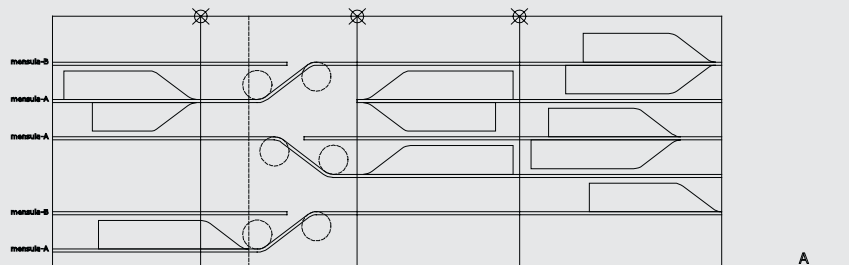
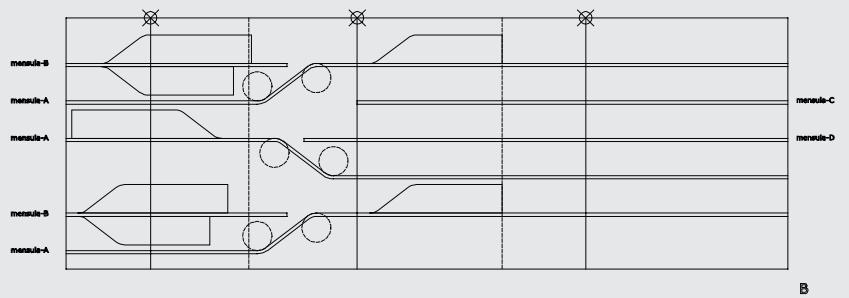
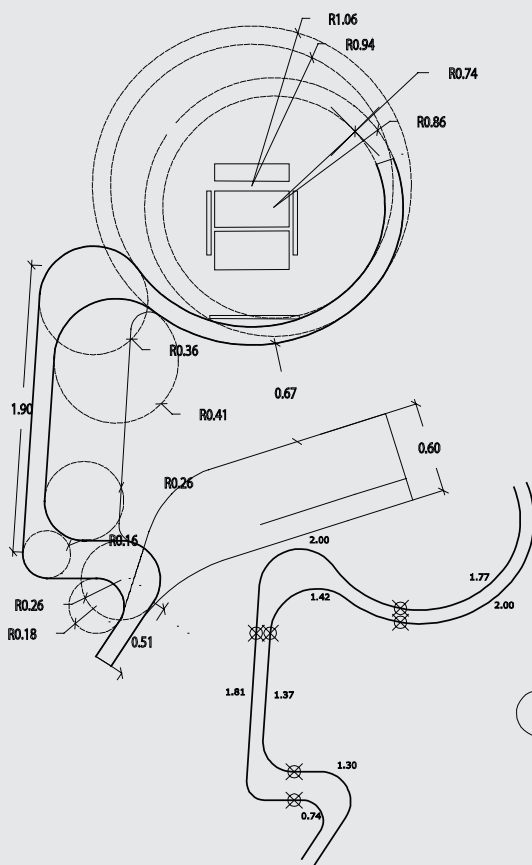

Plan and elevations of the sinuous wall by Corian

dance

a fluid Corian wall



dance concept

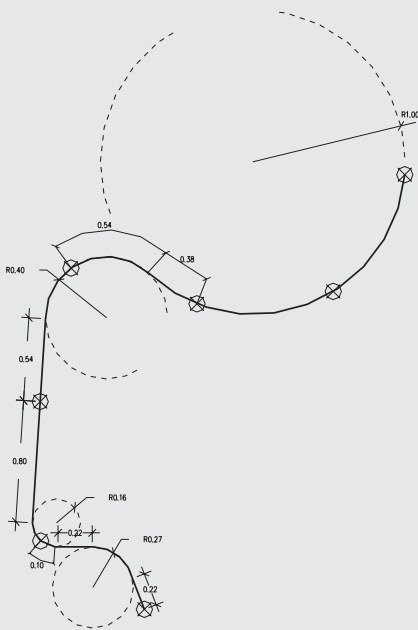

The separate design plays on the “see and not see” effect and allows for flexible changes.

With several initial concept studies on fluid light metacrilat partition walls, the final solution adopted, features ceiling hung Corian panels, CNC milled and thermoformed.

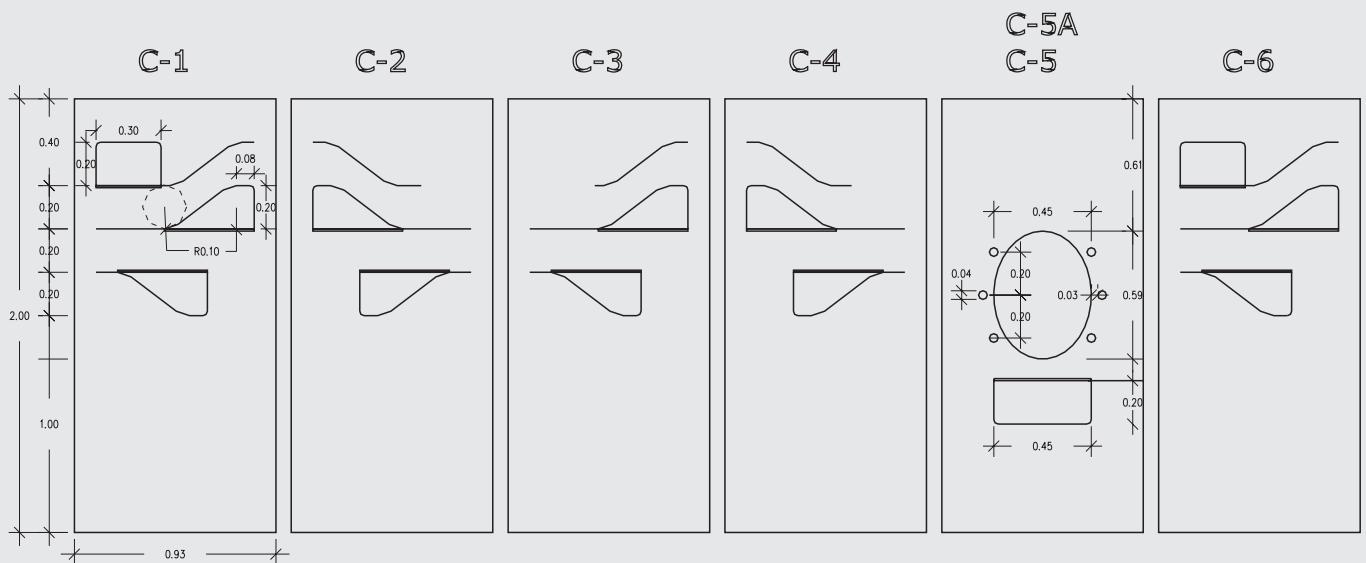

Detail drawings of holes of partition panels by Corian

dance

a fluid Corian wall



dance

a fluid Corian wall

